

PRODUCT DATA SHEET

TOUCHÉ CONTROLS



SMAOS—BOX MOUNTED

SMAOS-[L/H]-BOX-[CLR]



SMAOS
(SHOWN HERE IN WHITE)



TOUCHÉ WEBSITE



INSIGHT APP

DESCRIPTION

Touché Smart Sensors integrate Dual Technology Occupancy/Vacancy and Daylight sensing into a single device. These sensors are auto-addressing and pre-configured, eliminating the need for complicated dip-switches or dial adjustments. Sensors will automatically synchronize the sensing state across all connected devices, ensuring consistent operation without time-consuming individual commissioning. For applications requiring various sensor types (e.g., corner, wall, ceiling), sensors can be daisy-chained using CAT5 or higher cables.

Projects requiring sensors be mounted to electrical junction boxes must use SMAOS-[L/H]-BOX.

FEATURES

- **Touché SmartNet Device**
 - SmartNet Devices are auto-addressing and auto-configuring. Connection between SmartNet Devices are made via CAT5 or greater daisy-chained patch cables.
- **Dual Technology Sensing**
 - Passive Infrared (PIR) and Passive Acoustic
- **Daylight Sensing**
 - Simultaneous or exclusive Occupancy/Vacancy and Daylight Sensing
- **Lensing Options:**
 - Low: 360° ceiling mount coverage—mounting height < 20'
 - High: 360° ceiling mount coverage—mounting height ≥ 20'

PROJECT NAME/ID

NOTES

Touché Controls (a product of ESI Ventures)

📍 2085 Humphrey St, Fort Wayne, IN 46803

📞 888-841-4356

🌐 touchecontrols.com

🕒 05-2024

ORDER INFORMATION

PART ID		MOUNTING HEIGHT		MOUNTING TYPE		COLOR	
SMAOS	SMART SENSOR	LOW	CEILING HEIGHT ≤ 20'	BOX	BOX MOUNTED	WHT	WHITE
		HIGH	CEILING HEIGHT > 20'			BLK	BLACK

All Touché products are subject to a standard, 5-year warranty. For exact terms, refer to Touché Warranty Statement.

EXAMPLE CONNECTIVITY

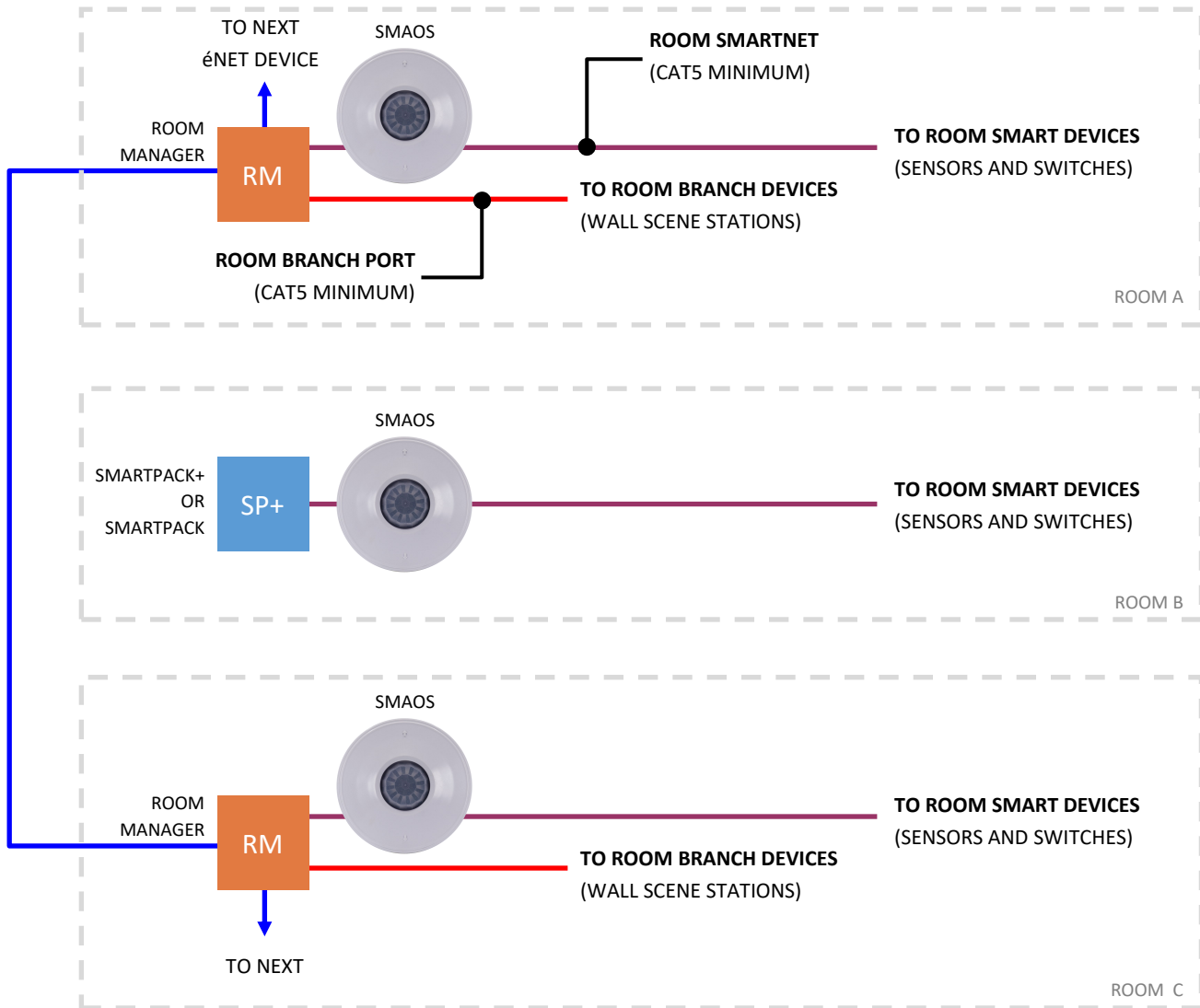

Touché Controls (a product of ESI Ventures)

📍 2085 Humphrey St, Fort Wayne, IN 46803

📞 888-841-4356

🌐 touchecontrols.com

🕒 05-2024

DIMENSIONS

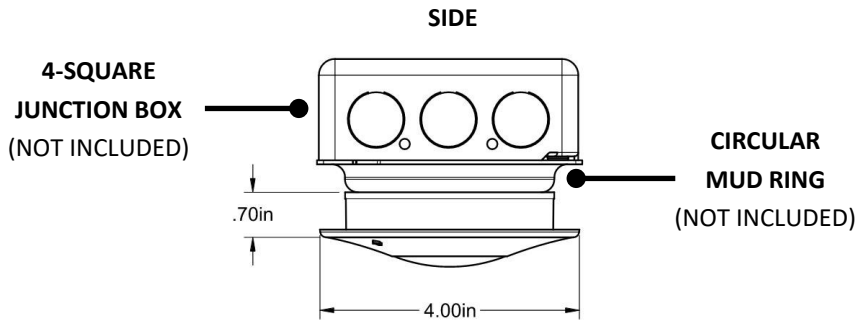

MOUNTING

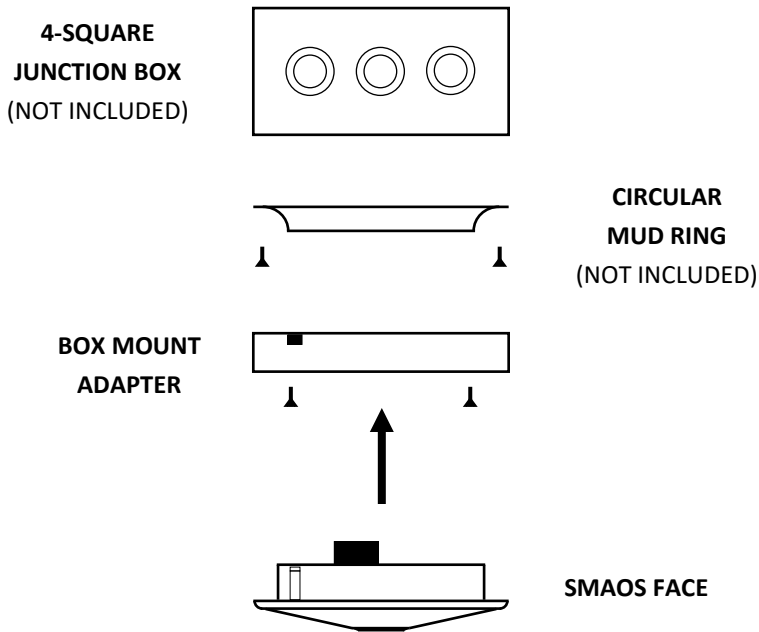

SPECIFICATIONS

TYPE	DESCRIPTION
POWER SUPPLY VOLTAGE	24VDC—SOURCED FROM SMARTNET (NO EXTERNAL POWER SUPPLY REQUIRED)
CONNECTIVITY	CAT5 (MINIMUM)
LISTINGS	UL916, cUL916
AMBIENT TEMPERATURE	60C (140F)
MAXIMUM HUMIDITY	10—90% NON-CONDENSING

Touché Controls (a product of ESI Ventures)

SENSOR COVERAGE—LOW MOUNTING

TOP VIEW

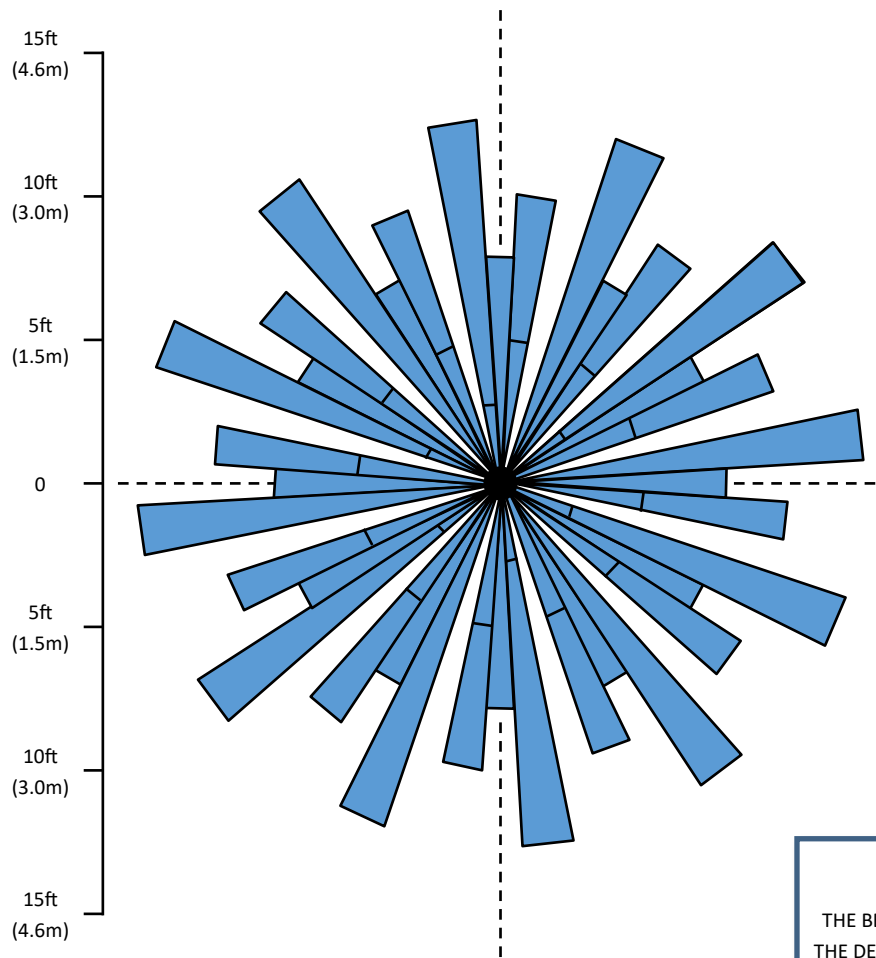

NOTE
THE BEAM PATTERN DEPENDS ON THE DETECTOR USED. THE PATTERN SHOWN IS INTENDED SOLELY AS A GENERAL GUIDE

SIDE VIEW

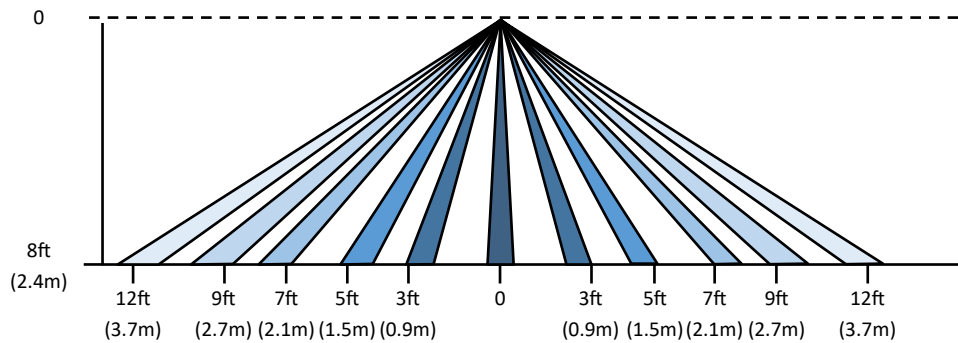

Touché Controls (a product of ESI Ventures)

📍 2085 Humphrey St, Fort Wayne, IN 46803

📞 888-841-4356

🌐 touchecontrols.com

🕒 05-2024

SENSOR COVERAGE—HIGH MOUNTING

TOP VIEW

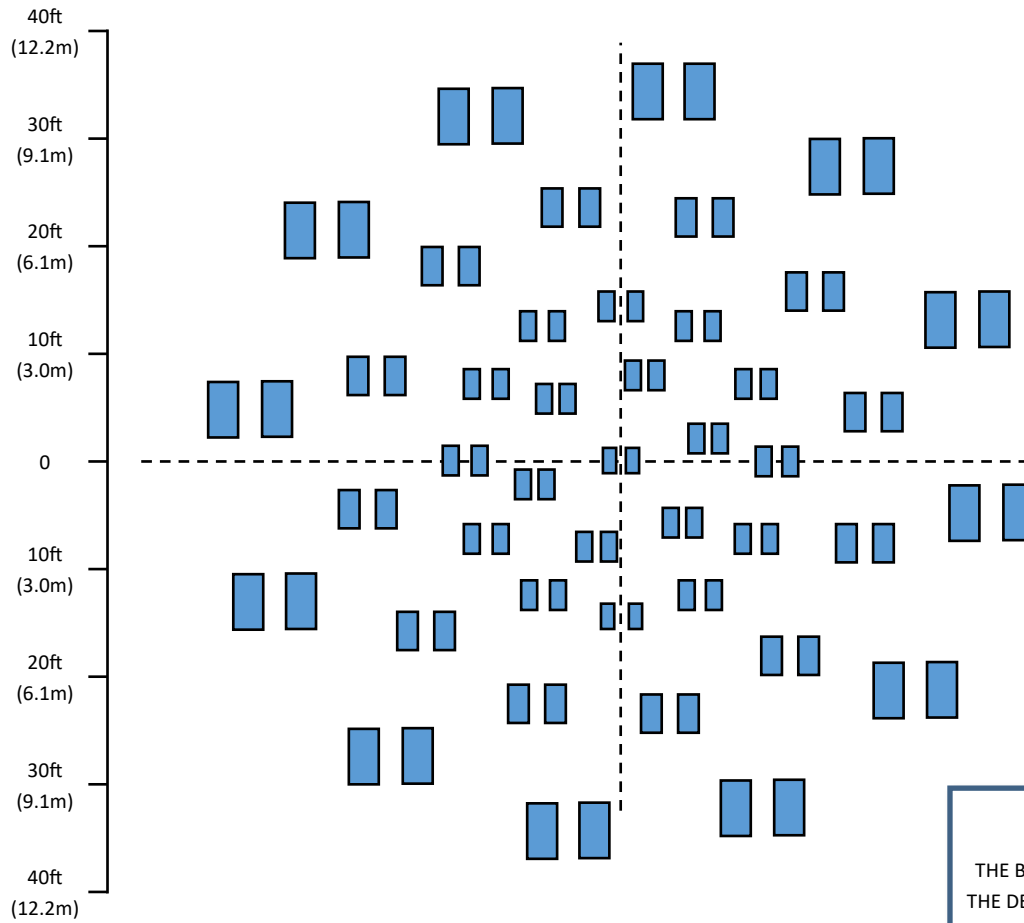

NOTE
 THE BEAM PATTERN DEPENDS ON
 THE DETECTOR USED. THE PATTERN
 SHOWN IS INTENDED SOLELY AS A
 GENERAL GUIDE

SIDE VIEW

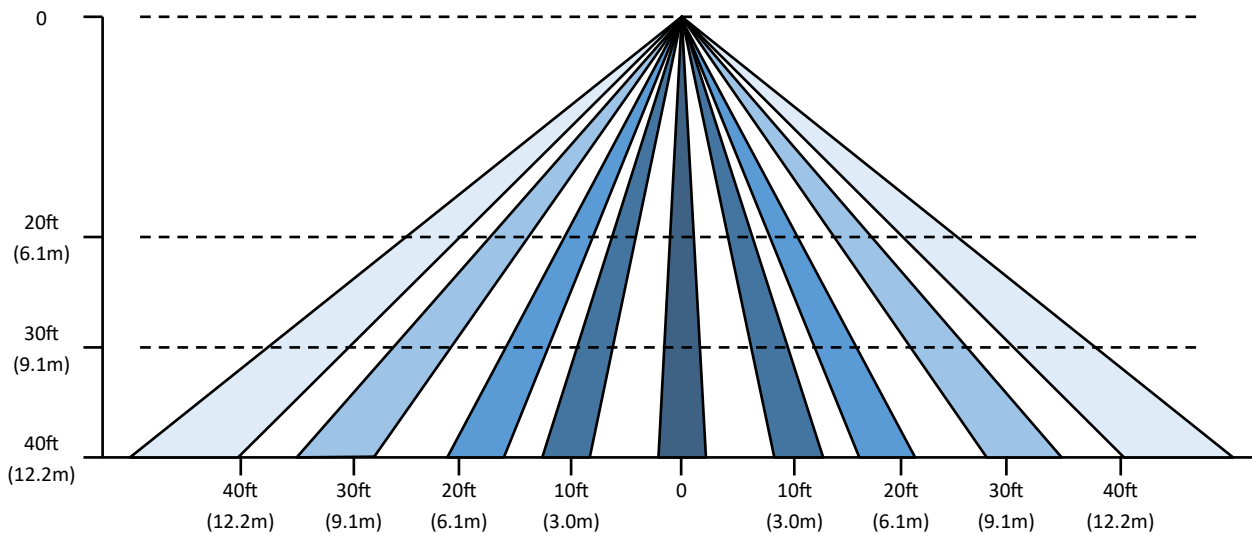

Touché Controls (a product of ESI Ventures)

📍 2085 Humphrey St, Fort Wayne, IN 46803

📞 888-841-4356

🌐 touchecontrols.com

🕒 05-2024